

 BLUE CHISEL | +91-93 27 00 68 43



WOW
incredibly beautiful!



INDEX

DELMA



06 - 09

FRIA



10 - 13

SSD



14 - 17

CUMA



18 - 21

MARIS



22 - 25

CARTO



26 - 29

DIONA



30 - 33

EBRO



34 - 37

ORANGE



38 - 41

DIAMOND



42 - 45

RICKO



46 - 49

CZER



50 - 53

RAINBOW



54 - 57

APPLE



58 - 61

SLIM



62 - 65

DADDU



66 - 69

HECTOR



70 - 73

SMART



74 - 77

ROYAL



78 - 81

SPARROW



82 - 83

NEXA



84

CONCEALED



85 - 87

SHOWER



88 - 91

FITTINGS



92 - 95

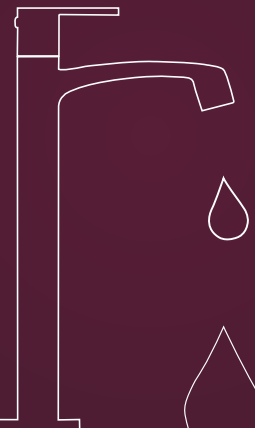

Taking a shower
in the bathroom
marks the beginning
of your day.
But what matters
more is how you
take a shower!
This thought is
our guiding force.

Flitz Designer Bath Fittings is an epitome in bathroom luxury. The company was founded with a long term vision of manufacturing and supplying designer bath fittings of next generation. Our quality policy and our designing standards complement each other.

We have a state-of-the-art manufacturing facility confirming to the highest standards in the industry. Stringent quality standards are followed at every stage of production. Flitz Designer Bath Fittings are tested for its perfection such that they look more like an art piece rather than hardware. Superior raw material, accurate dimensions and premium finish confirm our products to international quality parameters.

The company offers a huge range of designer bath fittings in a number of applications and designs. Our trendy designs match the most contemporary bathrooms, giving a premium bathing experience. Our design studio boast of the best-in-class designers with vivid imagination, a sharp understanding of usage and application and futuristic vision.

We have a wide dealer network in place across India. Our transparent system and supreme quality have earned us very high reliability in a very short period of time. Finest materials, industry-leading technology and classy design will continue to be our trump cards in the times to come.

www.flitz.co.in

OUR SUPERIOR FEATURES



THE JAPANESE RESILIENT CERAMIC DISC

Alumina is one of the hardest known material after diamond and that is what our Japanese technology ceramic discs are made of and fitted onto all our quarter turn ranges.



THE EUROPEAN SUPERIOR & HEAVY-DUTY CARTRIDGE

Our assurance of quality and performance on par with international brands has led to us fitting European cartridges for all our single lever ranges.

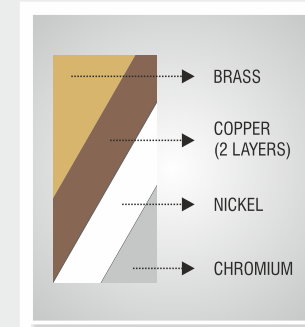

THE BRITISH STAND EVER LASTING HIGH GLOSS FITTINGS

Our range of kitchen and bathroom faucets have a four layer coating of nickel and chromium in accordance to British Standards service condition no. 2 & 3.

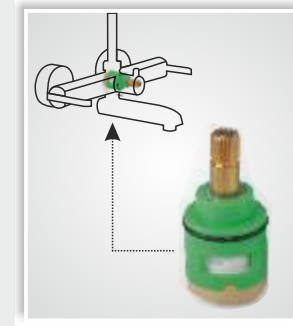

LAUNCHING FOR THE FIRST TIME IN INDIA WALL MIXER WITH FITTING CARTRIDGES

Here is a wall mixer with smooth movement at a half turn, with dual functionality for both shower head and spout for ease of use.



THE GERMAN FLAWLESS FOAM FLOW AERATORS

Want a picture perfect foam of aerated water than nothing beats our honey comb from the world leader, A German Brand. Enjoy the foam filled stream of aerated water with the right mix air with water which does not splash or spill.



QUALITY CONTROL APPROVED



PERFECT WATER FLOW



SUITABLE FOR HOT & COLD WATER



LOW MAINTAINACE



1001 BIB COCK



1002 LONG BODY
BIB COCK



1003 PILLAR COCK



SP 1003 LONG PILLAR
COCK



SP 1004 LONG NOSE HIGH
NECK PILLAR COCK



1005 SINGLE LEVER
BASING MIXER

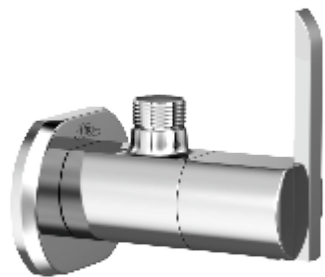

1006 ANGLE COCK



1007 SINK COCK



1007 B SINK COCK



1008 SWAN NECK



1009WM SINK MIXER
WALL MOUNTED



1010 SINGLE LEVER WALL
MOUNTED BASING MIXER
CONCEALED PARTS KIT



1011 2 IN 1 BIB COCK



1012 2 IN 1 WALL MIXER



1013 3 IN 1 WALL MIXER



1014 2 IN 1 WALL MIXER
WITH CRUNCH



1015 SINGLE LEVER
BASING MIXER
TABLE MOUNTED

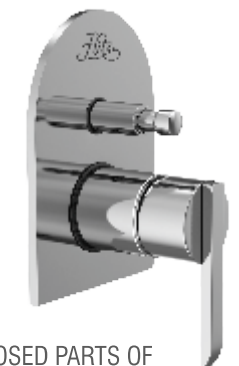

1016 EXPOSED PARTS OF
HIGH FLOW SINGLE LEVER
CONCEALED
DIVERTER 45 MM

DELMA

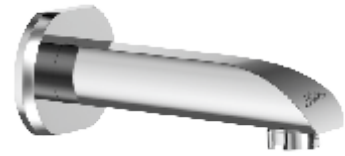

1017 BATH TUB SPOUT



1018 BATH SPOUT WITH
BUTTON ATTACHMENT



1019 WALL MIXER
NON TELEPHONIC



1022 EXPOSED PARTS KIT
OF CONCEALED STOP COCK
& FLUSH



1023 EXPOSED PARTS OF
SINGLE LEVER CONCEALED
DIVERTER 40 MM





2001 BIB COCK



2002 LONG BODY BIB COCK



2003 PILLAR COCK



2012 2 IN 1 WALL MIXER



2013 3 IN 1 WALL MIXER



2014 2 IN 1 WALL MIXER WITH CRUNCH

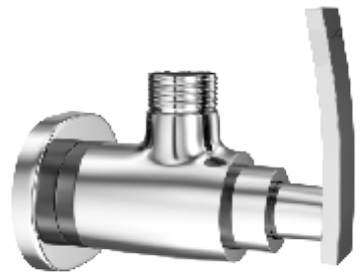

2006 ANGLE COCK



2007 SINK COCK



2008 SWAN NECK



2016 EXPOSED PARTS OF HIGH FLOW SINGLE LEVER CONCEALED DIVERTER 45 MM



2017 BATH TUB SPOUT



2019 WALL MIXER NON TELEPHONIC



2009WM SINC MIXER WALL MOUNTED



2009TM CENTER HOLE TABLE MOUNTED



2011 2 IN 1 BIB COCK



2022 EXPOSED PARTS KIT OF CONCEALED STOP COCK & FLUSH



2023 EXPOSED PARTS OF SINGLE LEVER CONCEALED DIVERTER 40 MM



WE PROVIDE ONE OF THE
BEST **FAUCETS**
IN THE **WORLD**





3002 LONG BODY
BIB COCK



3003 PILLAR COCK



3003 A PILLAR COCK



3009TM CENTER HOLE
TABLE MOUNTED



3010 SINGLE LEVER WALL
MOUNTED BASING MIXER
CONCEALED PARTS KIT



3011 2 IN 1 BIB COCK



3004 HIGH NECK
PILLAR COCK



3005 SINGLE LEVER
BASING MIXER

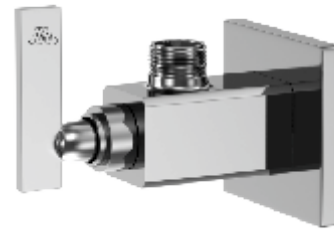

3006 ANGLE COCK



3012 2 IN 1 WALL MIXER



3013 3 IN 1 WALL MIXER



3014 2 IN 1 WALL MIXER
WITH CRUNCH



3007 SINK COCK



3008 SWAN NECK



3009WM SINK MIXER
WALL MOUNTED



3015 SINGLE LEVER BASING
MIXER TABLE MOUNTED



3016 EXPOSED PARTS
OF HIGH FLOW SINGLE
LEVER CONCEALED
DIVERTER 45 MM



3017 BATH TUB SPOUT

DESIGNS TO LEAVE YOU AMUSED



3019 WALL MIXER
NON TELEPHONIC



3022 EXPOSED PARTS KIT
OF CONCEALED
STOP COCK & FLUSH



3023 EXPOSED PARTS OF
SINGLE LEVER
CONCEALED
DIVERTER 40 MM





4001 BIB COCK



4002 LONG BODY
BIB COCK



4003 PILLAR COCK



SP 4003 LONG
PILLAR COCK



SP 4004 LONG NOSE HIGH
NECK PILLAR COCK



4005 SINGLE LEVER
BASING MIXER



4006 ANGLE COCK



4007 SINK COCK



4007 B SINK COCK



4008 SWAN NECK



4009WM SINK MIXER
WALL MOUNTED



4009TM CENTER HOLE
TABLE MOUNTED



4010 SINGLE LEVER WALL
MOUNTED BASING MIXER
CONCEALED PARTS KIT



4011 2 IN 1 BIB COCK



4012 2 IN 1 WALL MIXER



4013 3 IN 1 WALL MIXER



4014 2 IN 1 WALL MIXER
WITH CRUNCH



4015 SINGLE LEVER
BASING MIXER
TABLE MOUNTED

CUMA



4016 EXPOSED PARTS OF
HIGH FLOW SINGLE LEVER
CONCEALED
DIVERTER 45 MM

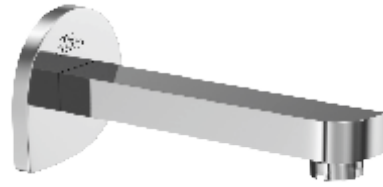

4017 BATH TUB SPOUT

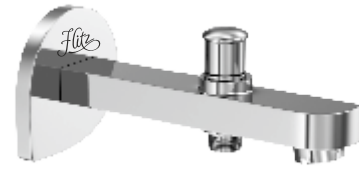

4018 BATH SPOUT WITH
BUTTON ATTACHMENT

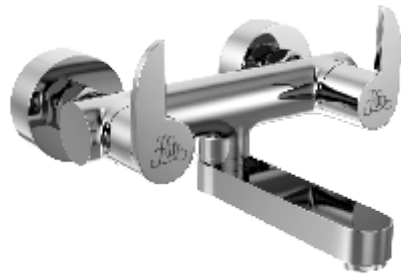

4019 WALL MIXER
NON TELEPHONIC



4022 EXPOSED PARTS KIT
OF CONCEALED
STOP COCK & FLUSH



4023 EXPOSED PARTS OF
SINGLE LEVER
CONCEALED
DIVERTER 40 MM



MARIS



5001 BIB COCK



5002 LONG BODY
BIB COCK



5003 PILLAR COCK



5012 2 IN 1 WALL MIXER



5013 3 IN 1 WALL MIXER



5014 2 IN 1 WALL MIXER
WITH CRUNCH



5006 ANGLE COCK



5007 SINK COCK



5008 SWAN NECK



5016 EXPOSED PARTS OF
HIGH FLOW SINGLE LEVER
CONCEALED
DIVERTER 45 MM



5017 BATH TUB SPOUT



5019 WALL MIXER
NON TELEPHONIC



5009WM SINC MIXER
WALL MOUNTED



5009TM CENTER HOLE
TABLE MOUNTED



5011 2 IN 1 BIB COCK



5022 EXPOSED PARTS KIT
OF CONCEALED
STOP COCK & FLUSH



5023 EXPOSED PARTS OF
SINGLE LEVER
CONCEALED
DIVERTER 40 MM



LOOKS **ELEGANT** AND **DECENT**





6001 BIB COCK



6002 LONG BODY
BIB COCK



6003 PILLAR COCK



6008 SWAN NECK



6009WM SINC MIXER
WALL MOUNTED



6009TM CENTER HOLE
TABLE MOUNTED



SP 6003 LONG
PILLAR COCK



SP 6004 LONG NOSE
HIGH NECK PILLAR COCK



6005 SINGLE LEVER
BASING MIXER



6010 SINGLE LEVER WALL
MOUNTED BASING MIXER
CONCEALED PARTS KIT



6011 2 IN 1 BIB COCK



6012 2 IN 1 WALL MIXER

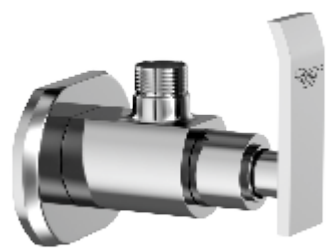

6006 ANGLE COCK



6007 SINK COCK



6007 B SINK COCK



6013 3 IN 1 WALL MIXER

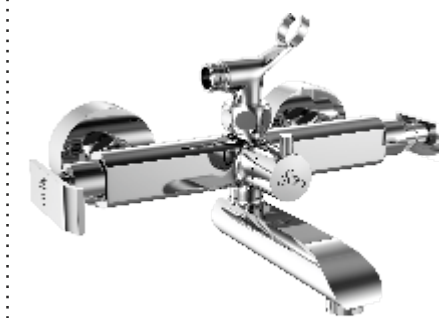

6014 2 IN 1 WALL MIXER
WITH CRUNCH

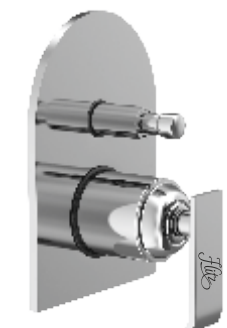

6016 EXPOSED PARTS OF
HIGH FLOW SINGLE LEVER
CONCEALED
DIVERTER 45 MM

CARTO

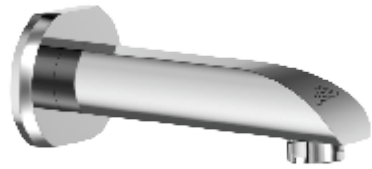

6017 BATH TUB SPOUT



6018 BATH SPOUT WITH
BUTTON ATTACHMENT



6019 WALL MIXER
NON TELEPHONIC



6022 EXPOSED PARTS KIT
OF CONCEALED
STOP COCK & FLUSH



6023 EXPOSED PARTS OF
SINGLE LEVER
CONCEALED
DIVERTER 40 MM



DIONA



7002 LONG BODY
BIB COCK



7003 PILLAR COCK



7003 A PILLAR COCK



7009TM CENTER HOLE
TABLE MOUNTED



7010 SINGLE LEVER WALL
MOUNTED BASING MIXER
CONCEALED PARTS KIT



7011 2 IN 1 BIB COCK



7004 HIGH NECK
PILLAR COCK



7005 SINGLE LEVER
BASING MIXER

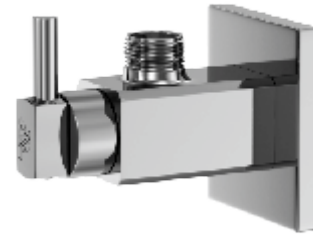

7006 ANGLE COCK



7012 2 IN 1 WALL MIXER



7013 3 IN 1 WALL MIXER



7014 2 IN 1 WALL MIXER
WITH CRUNCH



7007 SINK COCK



7008 SWAN NECK



7009WM SINK MIXER
WALL MOUNTED



7016 EXPOSED PARTS OF
HIGH FLOW SINGLE LEVER
CONCEALED
DIVERTER 45 MM

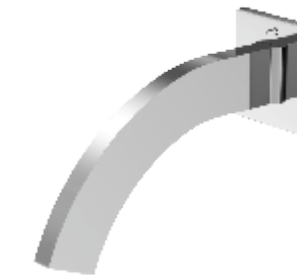

7017 BATH TUB SPOUT



7019 WALL MIXER
NON TELEPHONIC



FAUCET WITH THE BEST FEATURES



7022 EXPOSED PARTS KIT
OF CONCEALED
STOP COCK & FLUSH



7023 EXPOSED PARTS OF
SINGLE LEVER
CONCEALED
DIVERTER 40 MM





8001 BIB COCK



8002 LONG BODY
BIB COCK



8003 PILLAR COCK



8013 3 IN 1 WALL MIXER



8014 2 IN 1 WALL MIXER
WITH CRUNCH



8016 EXPOSED PARTS OF
HIGH FLOW SINGLE LEVER
CONCEALED
DIVERTER 45 MM

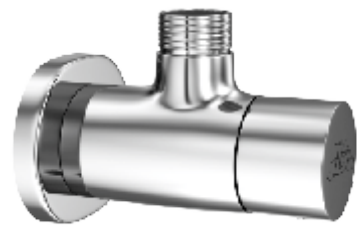

8006 ANGLE COCK



8007 SINK COCK



8008 SWAN NECK



8017 BATH TUB SPOUT



8019 WALL MIXER
NON TELEPHONIC



8022 EXPOSED PARTS KIT OF
CONCEALED
STOP COCK & FLUSH



8009 SINK MIXER
WALL MOUNTED



8011 2 IN 1 BIB COCK



8012 2 IN 1 WALL MIXER



8023 EXPOSED PARTS OF
SINGLE LEVER
CONCEALED
DIVERTER 40 MM

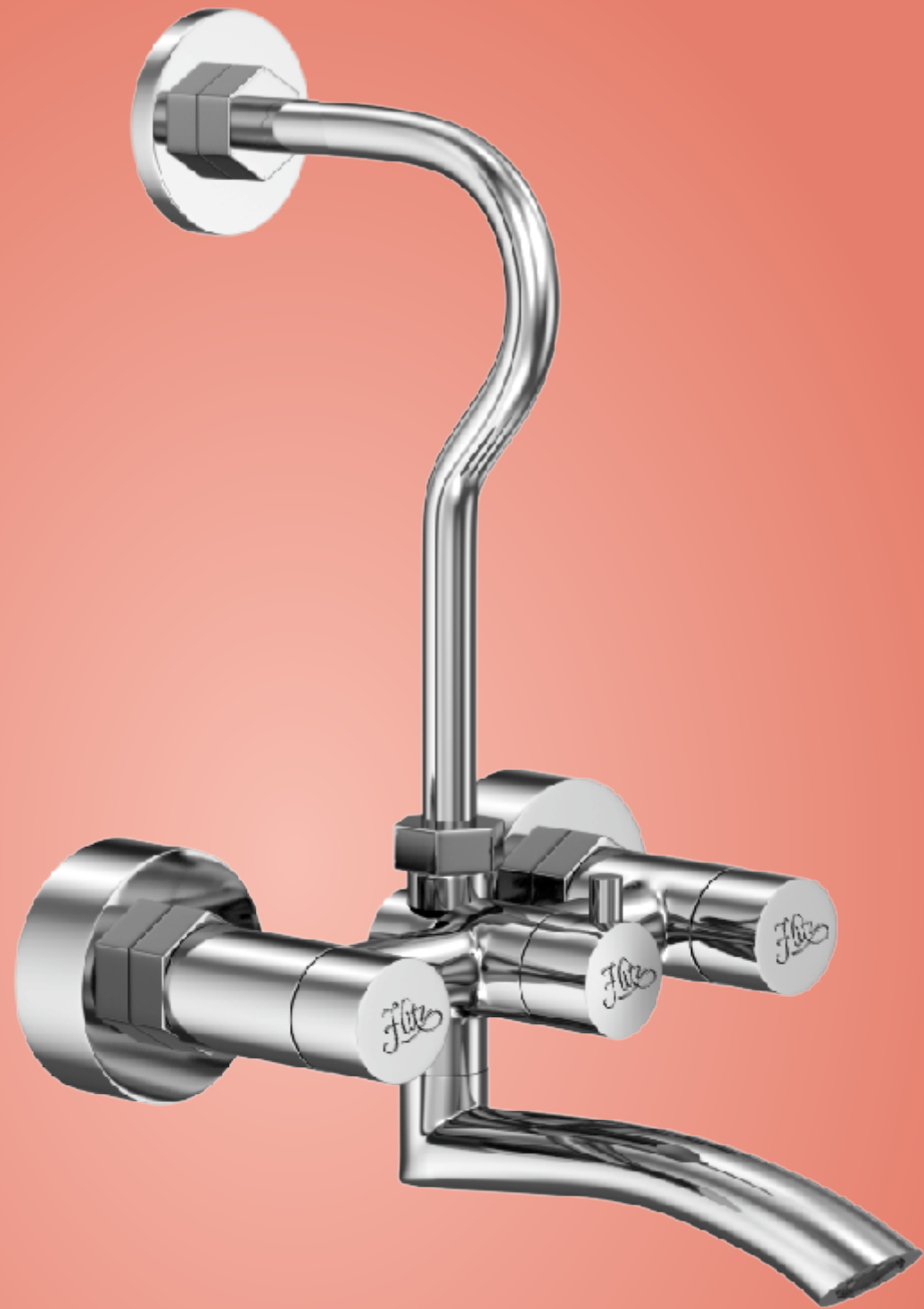

UPGRADE YOUR
BATHROOM DESIGN



ORANGE 20MM CERAMIC



4101 BIB COCK



4102 LONG BODY
BIB COCK



4103 PILLAR COCK



4108 SWAN NECK



4109WM SINK MIXER
WALL MOUNTED



4110 SINGLE LEVER WALL
MOUNTED BASING MIXER
CONCEALED PARTS KIT



SP 4103 LONG
PILLAR COCK



SP 4104 LONG NOSE
HIGH NECK PILLAR COCK



4105 SINGLE LEVER
BASING MIXER



4111 2 IN 1 BIB COCK



4112 2 IN 1 WALL MIXER



4113 3 IN 1 WALL MIXER

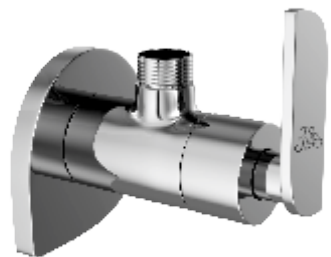

4106 ANGLE COCK



4107 SINK COCK



4107 B SINK COCK



4114 2 IN 1 WALL MIXER
WITH CRUNCH



4116 EXPOSED PARTS OF
HIGH FLOW SINGLE LEVER
CONCEALED
DIVERTER 45 MM



4117 BATH TUB SPOUT

ORANGE 20MM CERAMIC

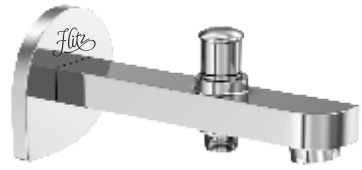

4118 BATH SPOUT WITH
BUTTON ATTACHMENT

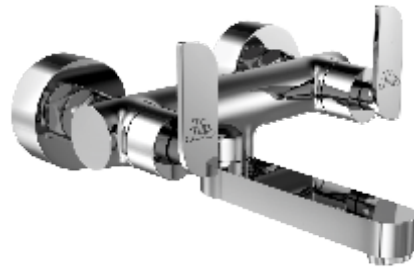

4119 WALL MIXER
NON TELEPHONIC



4122 EXPOSED PARTS KIT
OF CONCEALED
STOP COCK & FLUSH



4123 EXPOSED PARTS OF
SINGLE LEVER
CONCEALED
DIVERTER 40 MM



DIAMOND



4301 BIB COCK



4302 LONG BODY
BIB COCK



4303 PILLAR COCK



4309 TM CENTER HOLE
TABLE MOUNTED



4310 2 WAY ANGLE COCK



4311 2 IN 1 BIB COCK



SP 4303 LONG
PILLAR COCK



4304 HIGH NECK
PILLAR COCK

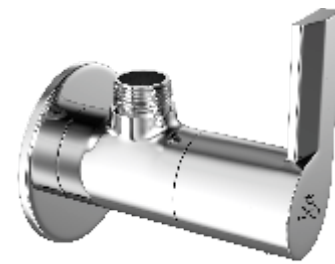

4306 ANGLE COCK



4312 2 IN 1 WALL MIXER



4313 3 IN 1 WALL MIXER

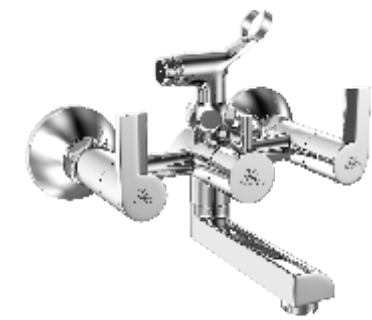

4314 2 IN 1 WALL MIXER
WITH CRUNCH



4307 SINK COCK



4308 SWAN NECK

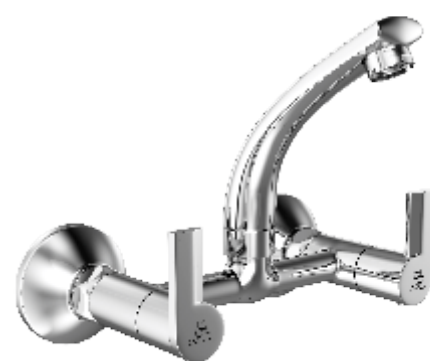

4309 WM SINK MIXER
WALL MOUNTED



4316 EXPOSED PARTS OF
HIGH FLOW SINGLE LEVER
CONCEALED
DIVERTER 45 MM

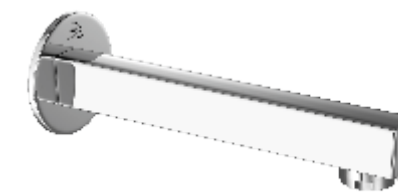

4317 BATH TUB SPOUT



4318 BATH SPOUT WITH
BUTTON ATTACHMENT



**GIVES YOUR HOUSE
A ROYAL LOOK**

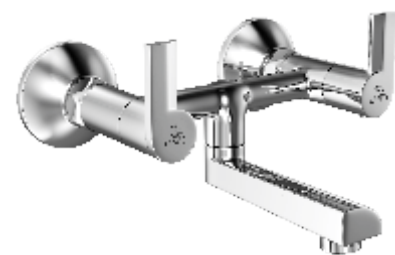

4319 WALL MIXER
NON TELEPHONIC



4322 EXPOSED PARTS KIT
OF CONCEALED
STOP COCK & FLUSH



4323 EXPOSED PARTS OF
SINGLE LEVER
CONCEALED
DIVERTER 40 MM





4201 BIB COCK



4202 LONG BODY
BIB COCK



4203 PILLAR COCK



4209 TM CENTER HOLE
TABLE MOUNTED



4210 2 WAY ANGLE COCK



4211 2 IN 1 BIB COCK



SP 4203 LONG
PILLAR COCK



4204 HIGH NECK
PILLAR COCK

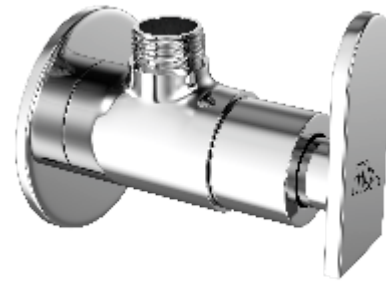

4206 ANGLE COCK



4212 2 IN 1 WALL MIXER



4213 3 IN 1 WALL MIXER

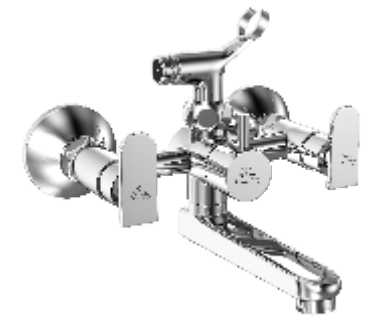

4214 2 IN 1 WALL MIXER
WITH CRUNCH



4207 SINK COCK



4208 SWAN NECK



4209 WM SINC MIXER
WALL MOUNTED



4216 EXPOSED PARTS OF
HIGH FLOW SINGLE LEVER
CONCEALED
DIVERTER 45 MM

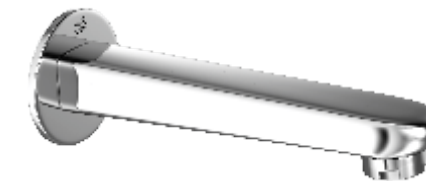

4217 BATH TUB SPOUT



4218 BATH SPOUT WITH
BUTTON ATTACHMENT



REDESIGN YOUR BATHROOM INTERIORS

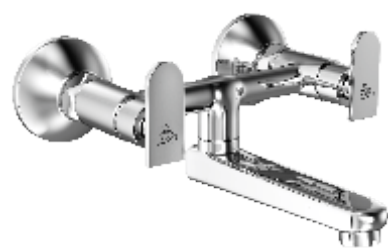

4219 WALL MIXER
NON TELEPHONIC



4222 EXPOSED PARTS KIT
OF CONCEALED
STOP COCK & FLUSH



4223 EXPOSED PARTS OF
SINGLE LEVER
CONCEALED
DIVERTER 40 MM





101 BIB COCK



102 LONG BODY
BIB COCK



103 PILLAR COCK



109TM CENTER HOLE
TABLE MOUNTED



110 2 WAY ANGLE COCK



111 2 IN 1 BIB COCK



104 HIGH NECK
PILLAR COCK



105 SINGLE LEVER
BASIN MIXER

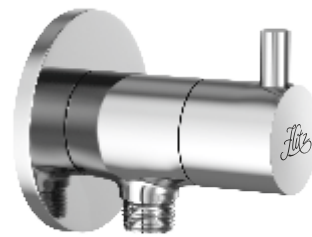

106 ANGLE COCK



112 2 IN 1 WALL MIXER



113 3 IN 1 WALL MIXER



114 2 IN 1 WALL MIXER
WITH CRUNCH



107 SINK COCK



108 SWAN NECK



109WM SINK MIXER
WALL MOUNTED



116 EXPOSED PARTS OF
HIGH FLOW SINGLE LEVER
CONCEALED
DIVERTER 45 MM



117 BATH TUB SPOUT



119 WALL MIXER
NON TELEPHONIC



MEET THE
MASTER OF **FAUCETS**



122 EXPOSED PARTS KIT
OF CONCEALED
STOP COCK & FLUSH



123 EXPOSED PARTS OF
SINGLE LEVER
CONCEALED
DIVERTER 40 MM



RAINBOW



301 BIB COCK



302 LONG BODY
BIB COCK



303 PILLAR COCK



309WM SINK MIXER
WALL MOUNTED



309TM CENTER HOLE
TABLE MOUNTED



310 2 WAY ANGLE COCK



SP 303 LONG
PILLAR COCK



304 HIGH NECK
PILLAR COCK



305 SINGLE LEVER
BASIN MIXER



311 2 IN 1 BIB COCK



312 2 IN 1 WALL MIXER



313 3 IN 1 WALL MIXER



306 ANGLE COCK



307 SINK COCK



308 SWAN NECK

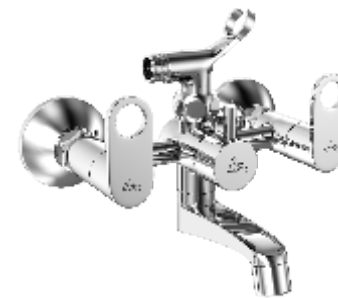

314 2 IN 1 WALL MIXER
WITH CRUNCH



316 EXPOSED PARTS OF
HIGH FLOW SINGLE LEVER
CONCEALED
DIVERTER 45 MM



317 BATH TUB SPOUT



DESIGNER FAUCETS FOR YOUR HOUSE

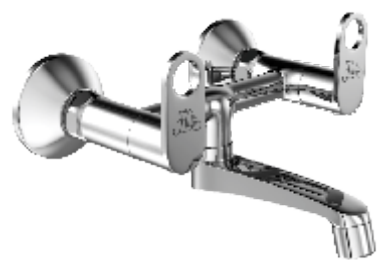

319 WALL MIXER
NON TELEPHONIC



322 EXPOSED PARTS KIT OF
CONCEALED
STOP COCK & FLUSH



323 EXPOSED PARTS OF
SINGLE LEVER
CONCEALED
DIVERTER 40 MM





401 BIB COCK



402 LONG BODY
BIB COCK



403 PILLAR COCK



409TM CENTER HOLE
TABLE MOUNTED



410 2 WAY ANGLE COCK



411 2 IN 1 BIB COCK



SP 403 LONG
PILLAR COCK



404 HIGH NECK
PILLAR COCK

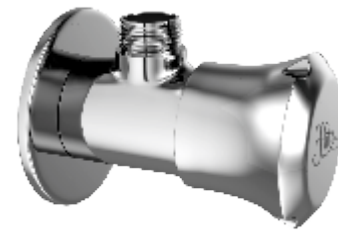

406 ANGLE COCK



412 2 IN 1 WALL MIXER



413 3 IN 1 WALL MIXER



414 2 IN 1 WALL MIXER
WITH CRUNCH



407 SINK COCK



408 SWAN NECK



409WM SINK MIXER
WALL MOUNTED



416 EXPOSED PARTS OF
HIGH FLOW SINGLE LEVER
CONCEALED
DIVERTER 45 MM



417 BATH TUB SPOUT

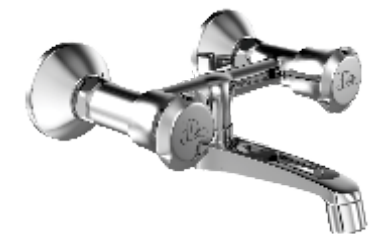

419 WALL MIXER
NON TELEPHONIC



**WORKS AS IF IT
RUNS ON MAGIC**



422 EXPOSED PARTS KIT OF
CONCEALED
STOP COCK & FLUSH



423 EXPOSED PARTS OF
SINGLE LEVER
CONCEALED
DIVERTER 40 MM



SLIM



501 BIB COCK



502 LONG BODY
BIB COCK



503 PILLAR COCK



509WM SINK MIXER
WALL MOUNTED



509TM CENTER HOLE
TABLE MOUNTED



510 2 WAY ANGLE COCK



SP 503 LONG
PILLAR COCK



504 HIGH NECK
PILLAR COCK



505 SINGLE LEVER
BASIN MIXER



511 2 IN 1 BIB COCK



512 2 IN 1 WALL MIXER



513 3 IN 1 WALL MIXER

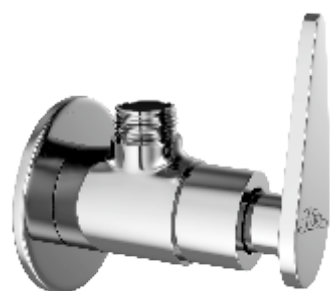

506 ANGLE COCK



507 SINK COCK



508 SWAN NECK



514 2 IN 1 WALL MIXER
WITH CRUNCH



516 EXPOSED PARTS OF
HIGH FLOW SINGLE LEVER
CONCEALED
DIVERTER 45 MM



517 BATH TUB SPOUT



TOUGH FINISHES GIVEN TO ALL FAUCETS

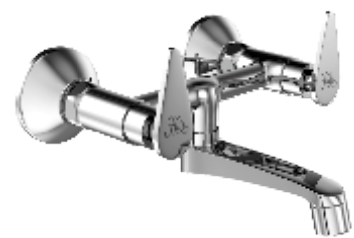

519 WALL MIXER
NON TELEPHONIC



522 EXPOSED PARTS KIT OF
CONCEALED
STOP COCK & FLUSH



523 EXPOSED PARTS OF
SINGLE LEVER
CONCEALED
DIVERTER 40 MM





601 BIB COCK



602 LONG BODY
BIB COCK



603 PILLAR COCK



609WM SINK MIXER
WALL MOUNTED



609TM CENTER HOLE
TABLE MOUNTED



610 2 WAY ANGLE COCK



SP 603 LONG
PILLAR COCK



604 HIGH NECK
PILLAR COCK



605 SINGLE LEVER
BASIN MIXER



611 2 IN 1 BIB COCK



612 2 IN 1 WALL MIXER



613 3 IN 1 WALL MIXER



606 ANGLE COCK



607 SINK COCK



608 SWAN NECK



614 2 IN 1 WALL MIXER
WITH CRUNCH



616 EXPOSED PARTS OF
HIGH FLOW SINGLE LEVER
CONCEALED
DIVERTER 45 MM



617 BATH TUB SPOUT

DADDU



618 BATH SPOUT WITH
BUTTON ATTACHMENT



619 WALL MIXER
NON TELEPHONIC



622 EXPOSED PARTS KIT OF
CONCEALED
STOP COCK & FLUSH



623 EXPOSED PARTS OF
SINGLE LEVER
CONCEALED
DIVERTER 40 MM



HECTOR



701 BIB COCK



702 LONG BODY
BIB COCK



703 PILLAR COCK



709WM SINK MIXER
WALL MOUNTED



709TM CENTER HOLE
TABLE MOUNTED



710 2 WAY ANGLE COCK



SP 703 LONG
PILLAR COCK



704 HIGH NECK
PILLAR COCK



705 SINGLE LEVER
BASIN MIXER



711 2 IN 1 BIB COCK



712 2 IN 1 WALL MIXER



713 3 IN 1 WALL MIXER

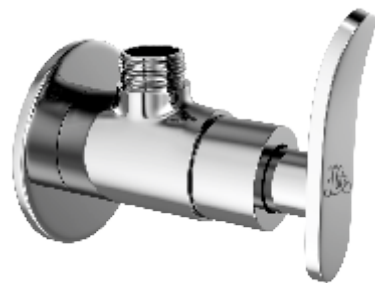

706 ANGLE COCK



707 SINK COCK



708 SWAN NECK



714 2 IN 1 WALL MIXER
WITH CRUNCH



716 EXPOSED PARTS OF
HIGH FLOW SINGLE LEVER
CONCEALED
DIVERTER 45 MM



717 BATH TUB SPOUT

HECTOR



718 BATH SPOUT WITH
BUTTON ATTACHMENT

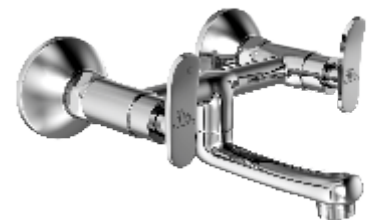

719 WALL MIXER
NON TELEPHONIC



722 EXPOSED PARTS KIT OF
CONCEALED
STOP COCK & FLUSH



723 EXPOSED PARTS OF
SINGLE LEVER
CONCEALED
DIVERTER 40 MM





801 BIB COCK



802 LONG BODY
BIB COCK



803 PILLAR COCK



809 TM CENTER HOLE
TABLE MOUNTED



810 2 WAY ANGLE COCK



811 2 IN 1 BIB COCK



SP 803 LONG
PILLAR COCK



804 HIGH NECK
PILLAR COCK



806 ANGLE COCK



812 2 IN 1 WALL MIXER



813 3 IN 1 WALL MIXER



814 2 IN 1 WALL MIXER
WITH CRUNCH



807 SINK COCK



808 SWAN NECK



809 WM SINK MIXER
WALL MOUNTED



816 EXPOSED PARTS OF
HIGH FLOW SINGLE LEVER
CONCEALED
DIVERTER 45 MM

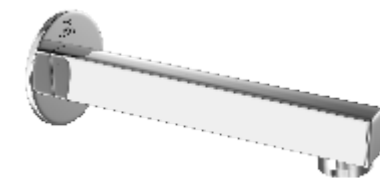

817 BATH TUB SPOUT



818 BATH SPOUT WITH
BUTTON ATTACHMENT



BEST FAUCET KING OF BATHROOM

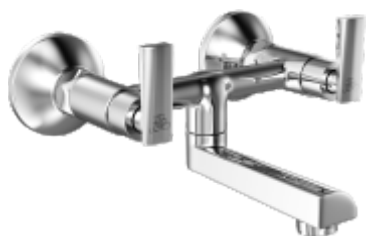

819 WALL MIXER
NON TELEPHONIC



822 EXPOSED PARTS KIT OF
CONCEALED
STOP COCK & FLUSH



823 EXPOSED PARTS OF
SINGLE LEVER
CONCEALED
DIVERTER 40 MM





901 BIB COCK



902 LONG BODY
BIB COCK



903 PILLAR COCK



909 TM CENTER HOLE
TABLE MOUNTED



910 2 WAY ANGLE COCK



911 2 IN 1 BIB COCK



SP 903 LONG
PILLAR COCK



904 HIGH NECK
PILLAR COCK



906 ANGLE COCK



912 2 IN 1 WALL MIXER



913 3 IN 1 WALL MIXER



914 2 IN 1 WALL MIXER
WITH CRUNCH



907 SINK COCK



908 SWAN NECK



909 WM SINK MIXER
WALL MOUNTED



916 EXPOSED PARTS OF
HIGH FLOW SINGLE LEVER
CONCEALED
DIVERTER 45 MM

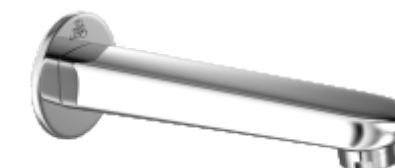

917 BATH TUB SPOUT



918 BATH SPOUT WITH
BUTTON ATTACHMENT



THE FAUCETS THAT REEK OF LUXURY

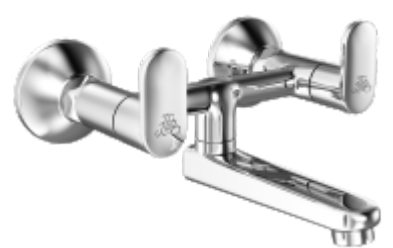

919 WALL MIXER
NON TELEPHONIC



922 EXPOSED PARTS KIT OF
CONCEALED
STOP COCK & FLUSH



923 EXPOSED PARTS OF
SINGLE LEVER
CONCEALED
DIVERTER 40 MM



SPARROW



4401 BIB COCK



4402 LONG BODY
BIB COCK



4405 ANGLE COCK TARBO



4406 ANGLE COCK SQ



4408 PUSH COCK MINI



4409 PUSH COCK MEDIUM

THE SILVERY SHINE THAT SPEAKS FOR ITSELF



NEXA



202 LONG BODY
BIB COCK



203 PILLAR COCK



SP 203 LONG
PILLAR COCK



204 HIGH NECK
PILLAR COCK



208S SWAN NECK



208R SWAN NECK



CONCEALED



0020 A CONCEALED
STOP COCK
BODY HEAVY 20 MM



0020 B CONCEALED
STOP COCK
BODY HEAVY 15 MM



0020 C CONCEALED
STOP COCK
BODY LIGHT 15 MM



0010 CONCEALED BODY
FOR SINGLE LEVER
BASING MIXER



0024 METERPOLE FLUSH
VALVE AUTO CLOSING
SYSTEM 40 MM (SQUARE)



0025 METERPOLE FLUSH
VALVE AUTO CLOSING
SYSTEM 40 MM (ROUND)



0021 A FLUSH
COCK BODY



0021 B FLUSH
COCK BODY



0021 C FLUSH
COCK BODY



0026 DRAIN VALVE 1/2 "

0027 DRAIN VALVE 3/4 "

0028 DRAIN VALVE 1"

0029 DRAIN VALVE 1 1/4"

0030 DRAIN VALVE 1 1/2"

0031 DRAIN VALVE 2"



0032
CONTROL VALVE 1/2 "

0033
CONTROL VALVE 3/4 "

0034
CONTROL VALVE 1 "

0035
CONTROL VALVE 1 1/2"



0036 BRASS BALL VALVE
S.S HANDLE 1/2"

0037 BRASS BALL VALVE
S.S HANDLE 3/4 "

0038 BRASS BALL VALVE
S.S HANDLE 1 "

0039 BRASS BALL VALVE
S.S HANDLE 1 1/4"

0040 BRASS BALL VALVE
S.S HANDLE 1 1/2"

0041 BRASS BALL VALVE
S.S HANDLE 2"

0042 BRASS BALL VALVE
S.S HANDLE 2 1/2"



0016 CONCEALED BODY
FOR SINGLE LEVER
HIGH FLOW DIVERTER
AUTO CUT 45 MM



0016B CONCEALED BODY
FOR SINGLE LEVER
HIGH FLOW DIVERTER
45 MM



0023 CONCEALED BODY
FOR SINGLE LEVER DIVERTER
40 MM

SHOWER



9001 SQUAR ULTRA SLIM 4X4



9002 SQUAR ULTRA SLIM 6X6



9003 SQUAR ULTRA SLIM 8X8



9010 SANDWICH SHOWER 6X6



9011 SANDWICH SHOWER 8X8



9012 LEAF SHOWER 4X4



9004 SQUAR ULTRA SLIM 10X10



9005 SQUAR ULTRA SLIM 12X12



9006 ROUND ULTRA SLIM 4X4



9013 CLASIC SHOWER



9014 PLATINA HAND SHOWER



9015 QUVBIC HAND SHOWER



9007 ROUND ULTRA SLIM 6X6



9008 ROUND ULTRA SLIM 8X8



9009 SANDWICH SHOWER 4X4



9016 SQUARE ARM 9"

9017 SQUARE ARM 12"

9018 SQUARE ARM 15"

9019 SQUARE ARM 18"



9020 ROUND ARM 9"

9021 ROUND ARM 12"

9022 ROUND ARM 15 "



9023 HF ROUND (ABS C.P.)

SHOWER



9024 HF SQUARE
(BRASS)

**GIVES WATER JUST
LIKE WATERFALL**



FITTINGS



4801 15MM CERAMIC CARTRIDGE REGULAR HEAVY



4802 15MM CERAMIC CARTRIDGE REGULAR LIGHT



4803 20MM CERAMIC CARTRIDGE



4811 47MM CARTRIDGE FOR SINGLE LEVER



4812 40MM METROPOLE KIT



4813 SQUARE AERATORS



4804 15MM CERAMIC CARTRIDGE MODUH OPPRET



4805 15MM CONCEALED CERAMIC CARTRIDGE



4806 20MM CONCEALED CERAMIC CARTRIDGE



4814 STANDARD AERATORS



4815 AERATORS INSIDE



4816 LAG PIPE SINGLE LIVER



4807 20MM RISING CARTRIDGE FLUSH
4808 25MM RISING CARTRIDGE FLUSH



4809 25MM CARTRIDGE FOR MIXER TIK TIK



4810 40MM CARTRIDGE FOR SINGLE LEVER



4817 SHOWER TUBE HEAVY 1MT
4818 SHOWER TUBE HEAVY 1.5MT
4819 SHOWER TUBE LIGHT 1MT
4820 SHOWER TUBE LIGHT 1.5MT



4821 BRASS WASTE COUPLING FULL THREAD 3"
4822 BRASS WASTE COUPLING FULL THREAD 6"



4823 S.S WASTE COUPLING FULL THREAD 3"
4824 S.S WASTE COUPLING FULL THREAD 6"

FITTINGS



4825 POPAP WASTE
COUPLING FULL
THREAD 3"
4826 POPAP WASTE
COUPLING FULL
THREAD 6"



4827 EXTENSION
NIPPLE 1"
4828 EXTENSION
NIPPLE 1.5"
4829 EXTENSION
NIPPLE 2"
4830 EXTENSION
NIPPLE 2.5"
4831 EXTENSION
NIPPLE 3"



4832 HEX NIPPLE



4840 BOTTLE TRAP
6" PIPE



4841 JET SPRAY MULTI
1mt
4842 JET SPRAY MULTI
1.5 mt



4843 CONNECTION PIPE
1FT
4844 CONNECTION PIPE
1.5 FT
4845 CONNECTION PIPE
2 FT
4846 CONNECTION PIPE
2.5 FT
4847 CONNECTION PIPE
3 FT



4833 BRACKET FOR
HAND SHOWER ABS



4834 WASTE PIPE HEAVY



4835 WAST PIPE LIGHT



4848 (103) COCKROACH
JALI SQUARE



4849 (102) COCKROACH
JALI SQUARE



4850 (101) COCKROACH
JALI SQUARE



4836 RACK BOLT
"T" TYPE 7"
4837 RACK BOLT
"T" TYPE 9"



4838 RACK BOLT 16MM
WITH CAP



4839 RACK BOLT 10MM
SCREW



4851 (100) COCKROACH
JALI SQUARE



4852 (PIPE) COCKROACH
JALI SQUARE